

Slicer TS700

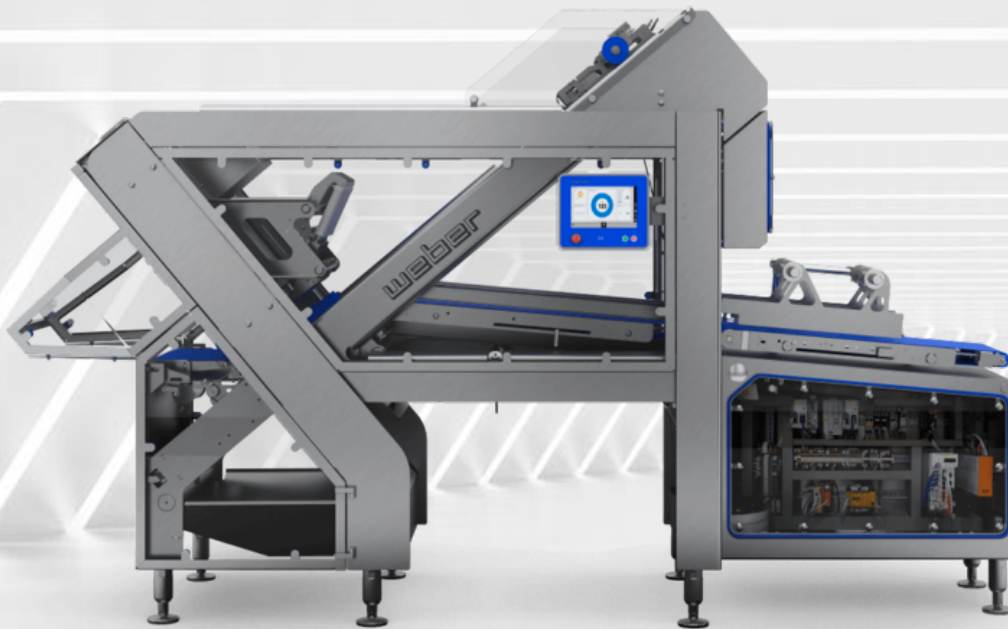

Product details

- Large product throughput and very short reloading
- Slicer for awide range of products and applications
- Unique open design concept

View online



Advantages

 Involute blade

 Performance involute blade

 Weber Hygiene Design

 Vacuum gripper

 Variogripper

 Quick set-up time

 SprayTech

 Interleaver

 Automatic loading













Slicer TS700

The combination of large product throughput and very short reloading time make the Weber Slicer TS700 a powerful and optimal solution for a wide range of products and applications. Gentle slicing of the product and high output are a matter of course.

Moreover, the efficient TS700 convinces with a new open design and innovative slicer functions. The unique open design concept helps you to reduce cleaning times to a minimum through accessibility, ease of maintenance and hygiene.

- GripnGo reloading function
- VarioFeed Product Feeder
- ContiFlow - Slicing without reloading gaps

Presentation

-  Stacked
-  Shingled
-  Shaved
-  Multiple-overlaps - single/mixed
-  Staggered Stack
-  Shingled-with-interleave
-  Folded
-  stacked-with-interleave
-  Endless-shingled
-  Portion-designer
-  Shingled-stack
-  Pieces
-  Overlapped - single/mixed

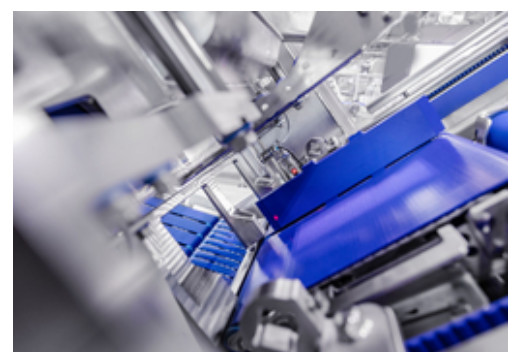
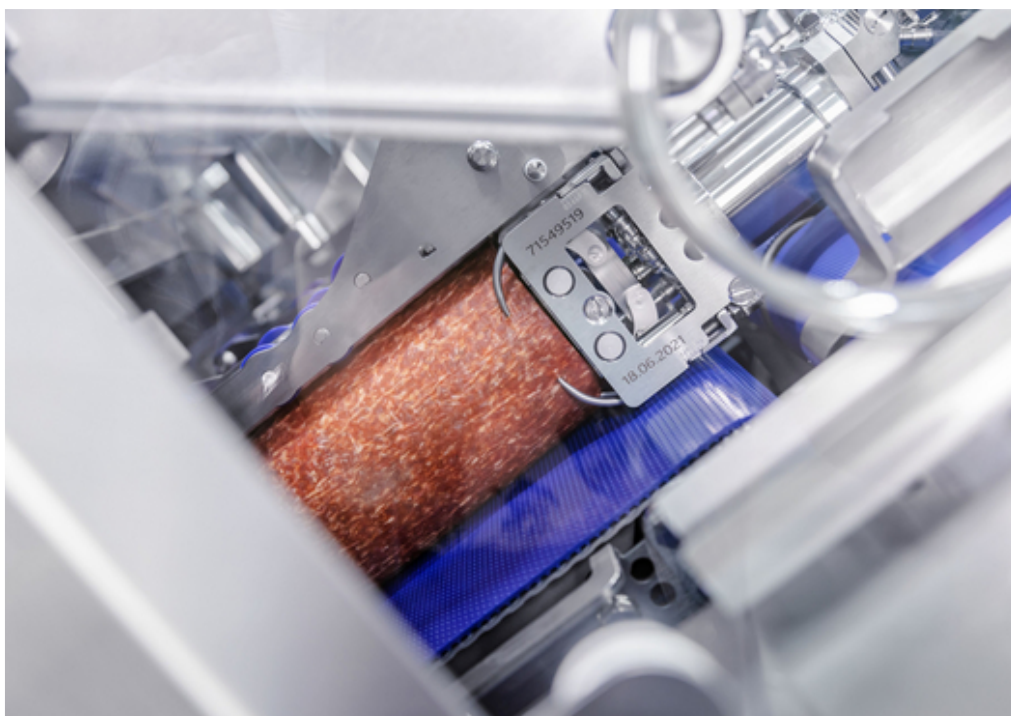

Technical Data Slicer TS700

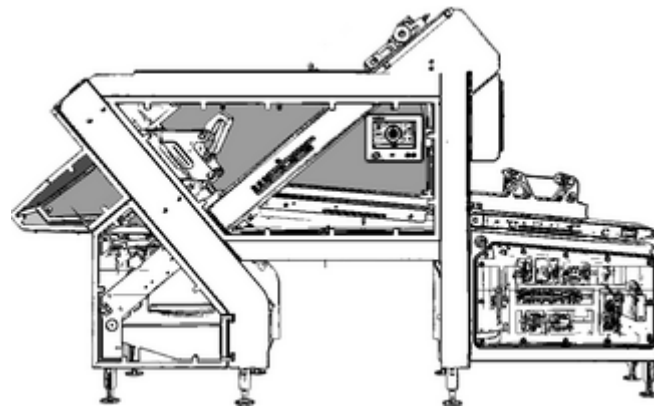

Product throat height (mm)	200 - 220
Product throat width (mm)	450 - 500
Product length (mm)	1200, 1600, 1850
Slicing system	Involute blade system
Loading (automatic/manual)	automatically
Involute blade cutting speed (rpm)	max. 1850

Weber means: service across the board.



Weber Academy.

Maximize line performance through professional training courses.

At the Weber Headquarter in Breidenbach, Germany, we have our own training center, the Weber Academy. Being a provider of complete line solutions, we offer training courses for your Weber Line, tailored precisely to your needs. In doing so, our focus is always on increasing efficiency and optimizing profit in your company.



Weber Guardian.

A safe plan for your production.

Only those who listen can understand. And those who understand can act. With our Weber Guardian program, we harmonize people, machines, and processes to get the most out of production. From preventive maintenance and inspection through targeted personnel development to production support and optimization.



Weber Portal.

Networked thinking, handling together.

You will find everything about your Weber equipment bundled in your personal Weber Portal. Compact, individual and interactive. From your customer profile and that of your machines to e-learning on your setup as well as convenient spare parts ordering and service offers. Are you already registered?

We are looking forward to your message.



Rob Unwin
Operations Director



Andre Clareboets
Joint Head of Sales



Tom Foran
Divisional Manager –
Slicing & Packaging Solutions

Legal notice

This document was generated automatically on 09/05/2023. All information is non-binding. We reserve the right to make changes in the interest of technical progress. For the latest information on this product, please visit: <https://www.weberweb.com/portfolio/slicer/slicer-ts700/>